

# SensorSwitch™ Application Solution Guide



## The Standalone Wired or Wireless Lighting Controls for Indoor or Outdoor Spaces, You Can Count On

- **Wired or Wireless:** Choose wired SensorSwitch or wireless SensorSwitch AIR products designed with proven technology
- **Install & Go:** Out-of-the-box operation to address rebate programs and simple code compliance
- **For Your Projects:** For new construction and retrofit spaces, including indoor room-based, industrial or outdoor
- **Embedded Controls:** Available in over 200 Acuity Brands luminaire families
- **Find it Easily:** Stocked at your local distributor or available in as little as two days

### About This Guide:

The SensorSwitch Application Solution Guide serves as a reference for typical SensorSwitch layouts in classrooms, offices, warehouse, and other applications. For additional information, visit [sensorswitch.com](http://sensorswitch.com)



## / TABLE OF CONTENTS

---

- 04** Classroom - Wired
- 05** Classroom - Wireless Embedded
- 06** Classroom - Wireless
- 07** Conference Room - Wired
- 08** Conference Room - Wireless
- 09** Open Office - Wired
- 10** Open Office - Wireless
- 11** Private Office - Wired
- 12** Private Office - Wireless Embedded
- 13** Private Office - Wireless
- 14** Warehouse - Wired Embedded
- 15** Warehouse - Wired Field Installable
- 16** Restroom - Wired
- 17** Public Restroom - Wireless
- 18** Residential - Wired
- 19** Residential - Kitchen Wired



# Classroom: With Wired SensorSwitch Control Devices

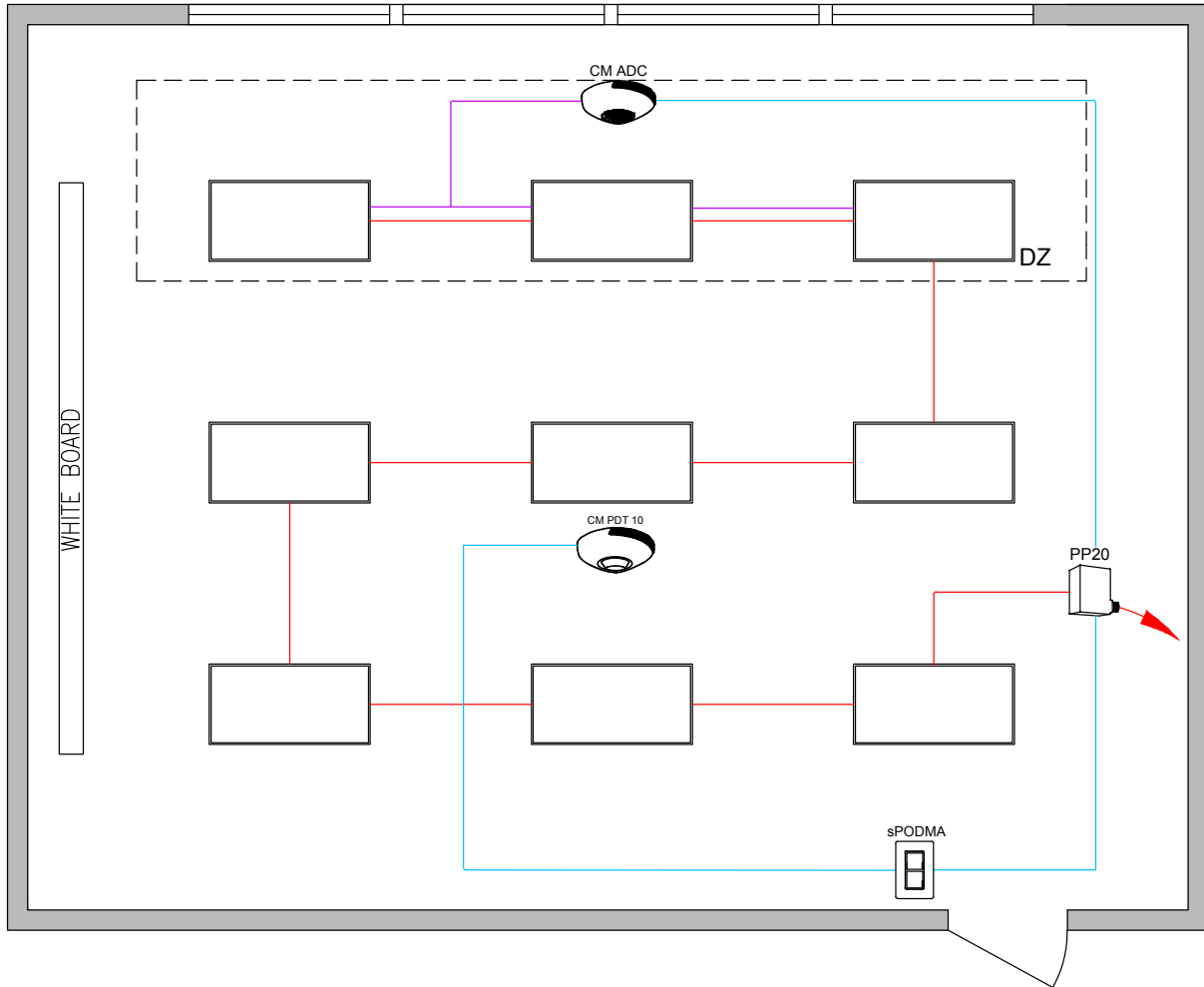

BILL OF MATERIAL		
QTY	PRODUCT #	DESCRIPTION
1	PP20	RELAY MODULE
1	SPODMA*	ON/OFF WALL SWITCH
1	CM PDT 10	DUAL TECHNOLOGY CEILING MOUNT OCCUPANCY SENSOR
1	CM ADC	AUTO DIMMING PHOTOCCELL



DIAGRAM LEGEND	
	0-10 VDC DIMMING WIRES
	CLASS 2 LOW VOLTAGE
	LINE VOLTAGE WIRES
	LINE FEED

\*For a vacancy application, use the SPODMA SA – manual on, auto off

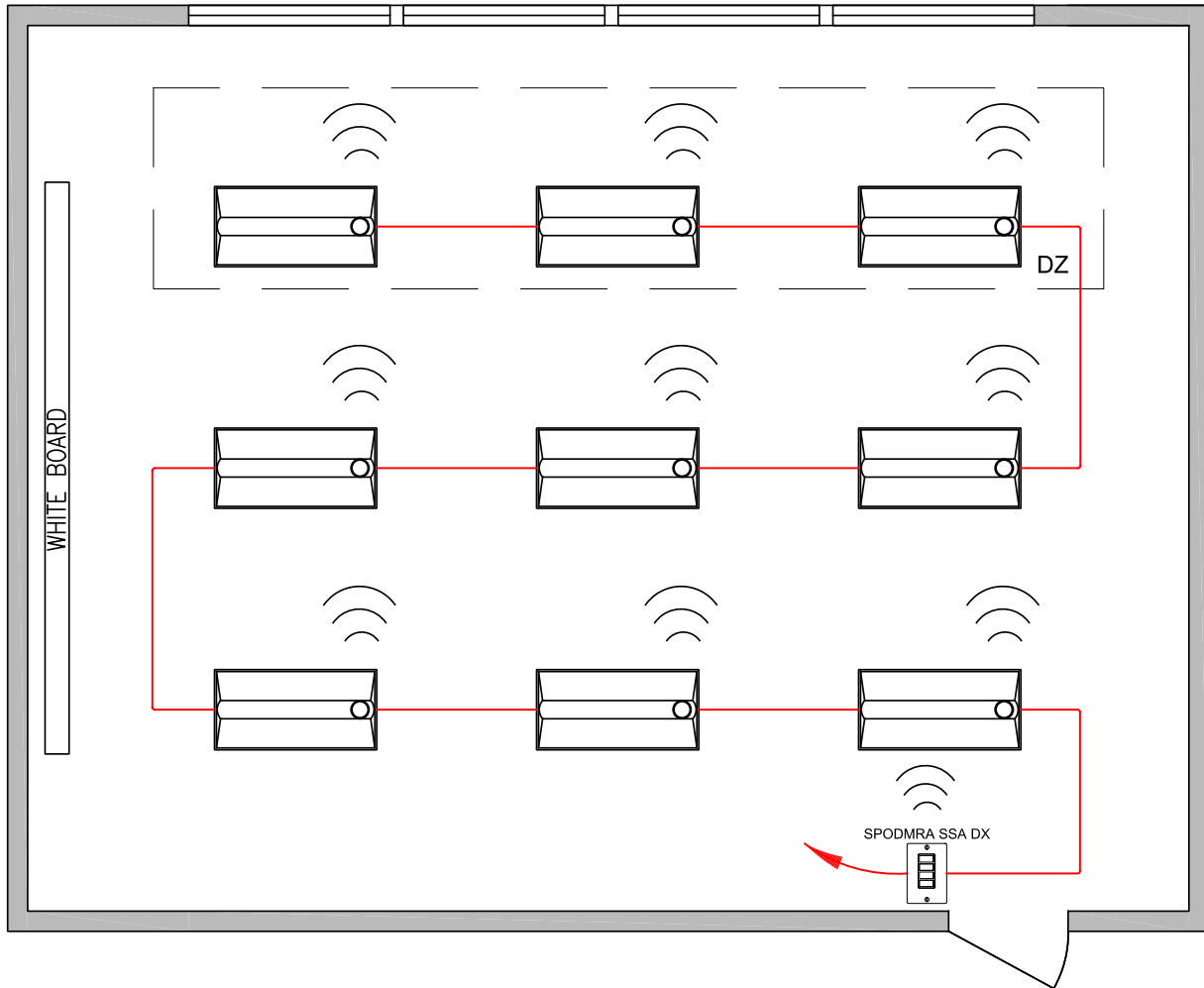
# Classroom: With Wireless SensorSwitch AIR Embedded Control Devices



BILL OF MATERIAL		
QTY	PRODUCT #	DESCRIPTION
9	SEE NOTE	LITHONIA LIGHTING TROFFERS WITH WIRELESS EMBEDDED CONTROLS FROM SENSORSWITCH
1	SPODMRA SSA DX	WIRELESS SENSORSWITCH AIR ON/OFF AND DIMMING WALL SWITCH

Wiring Legend	
	Line Voltage Wires
	Line Power

# Classroom: With Wireless SensorSwitch AIR Control Devices

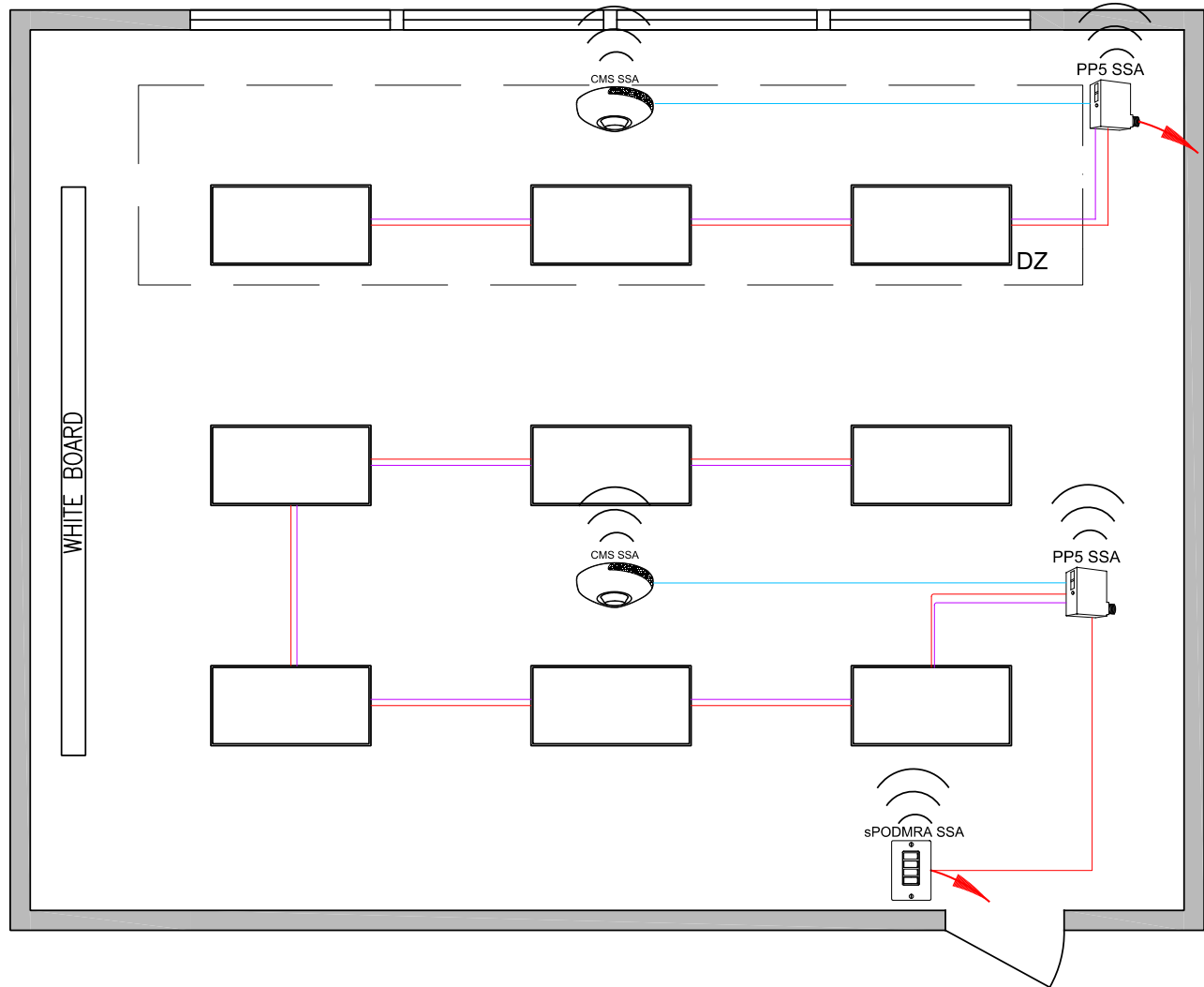

BILL OF MATERIAL		
QTY	PRODUCT #	DESCRIPTION
2	PP5 SSA D 24V	WIRELESS 0-10V DIMMING POWER PACK
1	SPODMRA SSA DX	WIRELESS DIMMING WALL SWITCH
2	CMS SSA PDT 9	DUAL TECHNOLOGY CEILING MOUNTED OCCUPANCY SENSOR



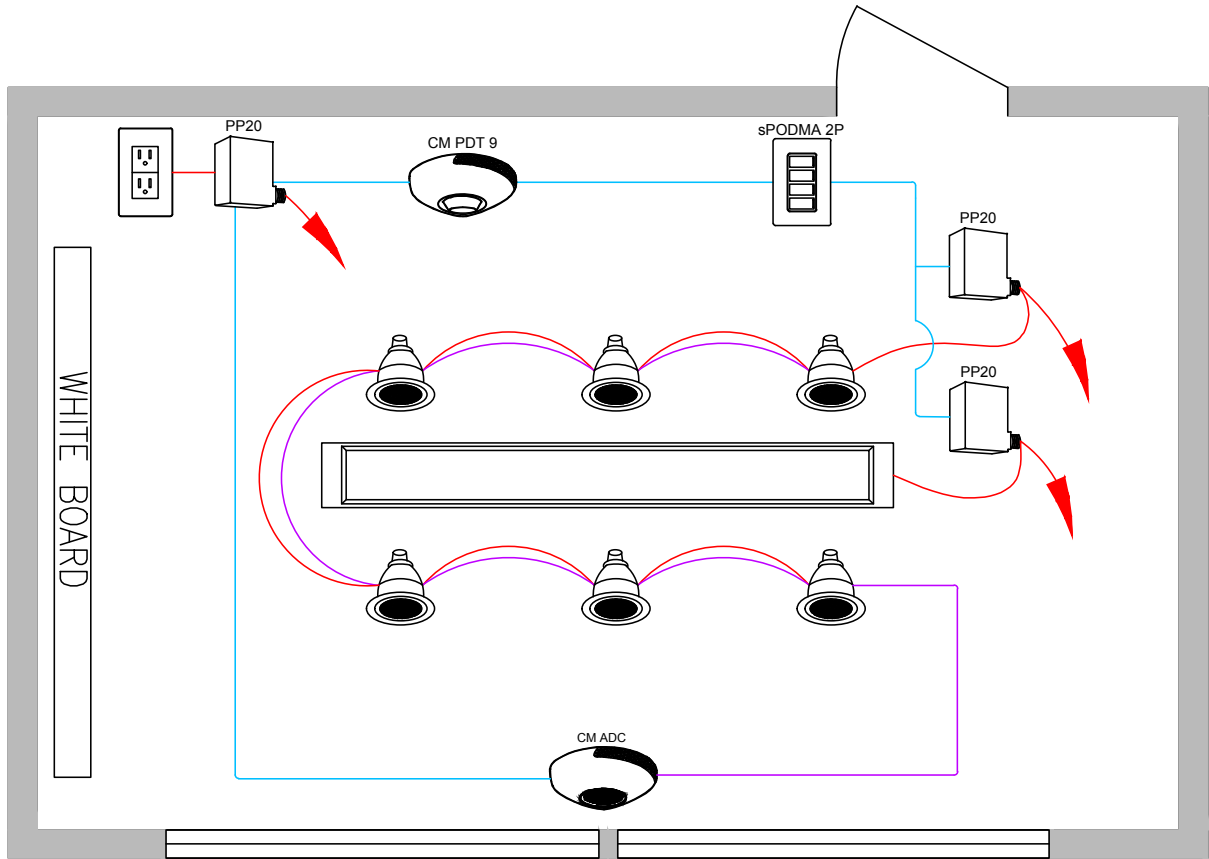

DIAGRAM LEGEND	
	0-10 VDC DIMMING WIRES
	CLASS 2 LOW VOLTAGE WIRES
	LINE VOLTAGE WIRES
	LINE FEED

Wireless SensorSwitch AIR is backwards compatible with all SensorSwitch JOT products.

# Conference Room: With Wired SensorSwitch Control Devices



BILL OF MATERIAL		
QTY	PRODUCT #	DESCRIPTION
3	PP20	RELAY MODULE
1	SPODMA 2P*	2 POLE ON/OFF WALL SWITCH
1	CM PDT 9	DUAL TECHNOLOGY CEILING MOUNT OCCUPANCY SENSOR
1	CM ADC	AUTO DIMMING PHOTOCELL

DIAGRAM LEGEND	
	0-10 VDC DIMMING WIRES
	CLASS 2 LOW VOLTAGE
	LINE VOLTAGE WIRES
	LINE FEED

\*For a vacancy application, use the SPODMA 2P 2SA – manual on, auto off

# Conference Room: With Wireless SensorSwitch AIR Control Devices

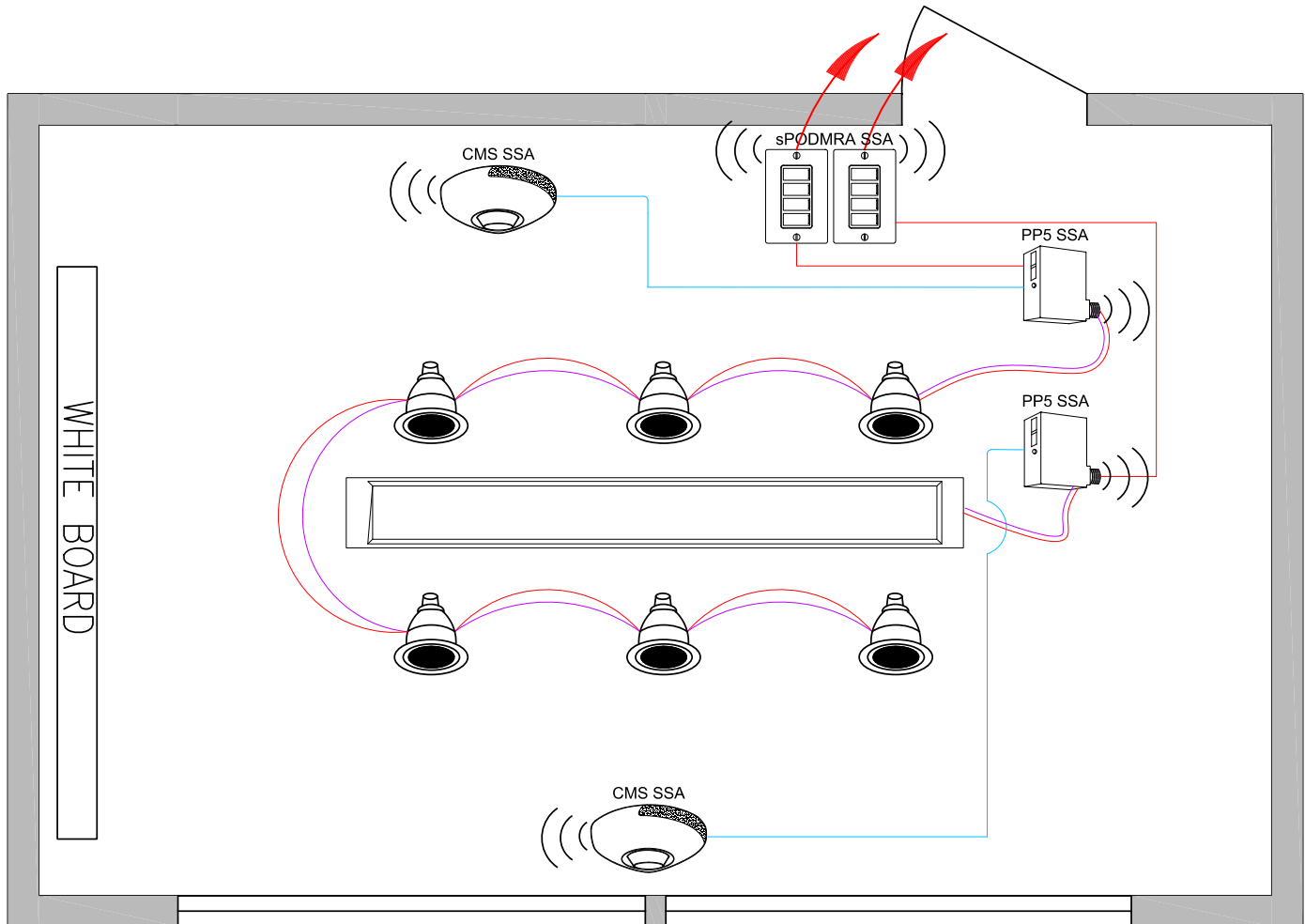

BILL OF MATERIAL		
QTY	PRODUCT #	DESCRIPTION
2	PP5 SSA D 24V	WIRELESS 0-10V DIMMING POWER PACK
2	SPODMRA SSA DX	WIRELESS DIMMING WALL SWITCH
2	CMS SSA PDT 9	CEILING MOUNTED WIRELESS OCCUPANCY/PHOTO SENSOR
6	SEE NOTE	0-10V DIMMABLE DOWNLIGHTS
1	SEE NOTE	0-10V DIMMABLE LINEAR LUMINAIRE



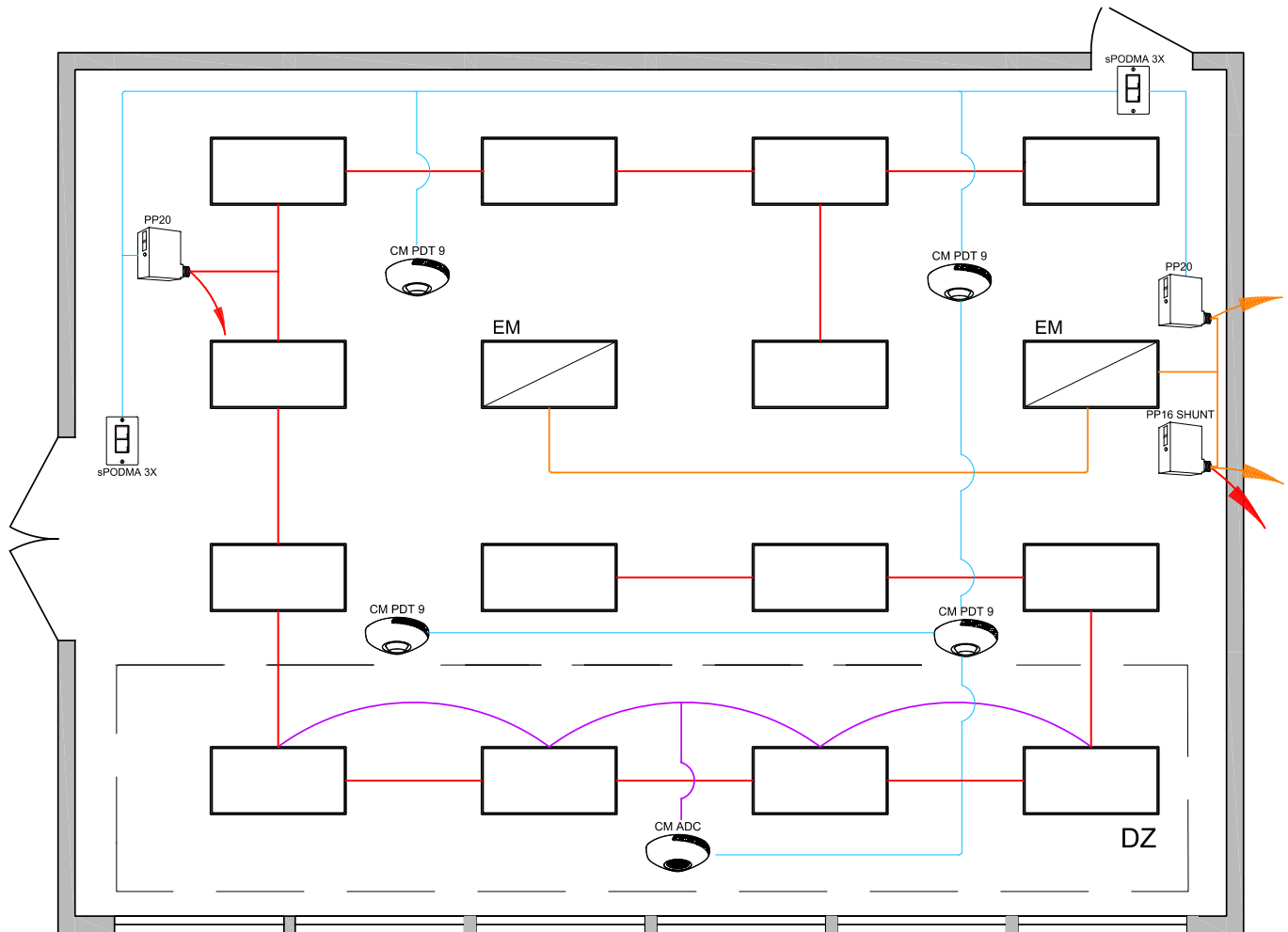

DIAGRAM LEGEND	
	0-10 VDC DIMMING WIRES
	CLASS 2 LOW VOLTAGE WIRES
	LINE VOLTAGE WIRES
	LINE FEED

Wireless SensorSwitch AIR is backwards compatible with all SensorSwitch JOT products.

# Open Office: With Wired SensorSwitch Control Devices



BILL OF MATERIAL		
QTY	PRODUCT #	DESCRIPTION
2	PP20	RELAY MODULE
1	PP16 SHUNT	EM SHUNT RELAY PACK
2	SPODMA 3X	ON/OFF 3-WAY SWITCH
4	CM PDT 9	DUAL TECHNOLOGY CEILING MOUNT OCCUPANCY SENSOR
1	CM ADC	AUTO DIMMING PHOTOCELL

DIAGRAM LEGEND	
	0-10 VDC DIMMING WIRES
	CLASS 2 LOW VOLTAGE WIRES
	LINE VOLTAGE WIRES
	LINE FEED

# Open Office: With Wireless SensorSwitch AIR Control Devices

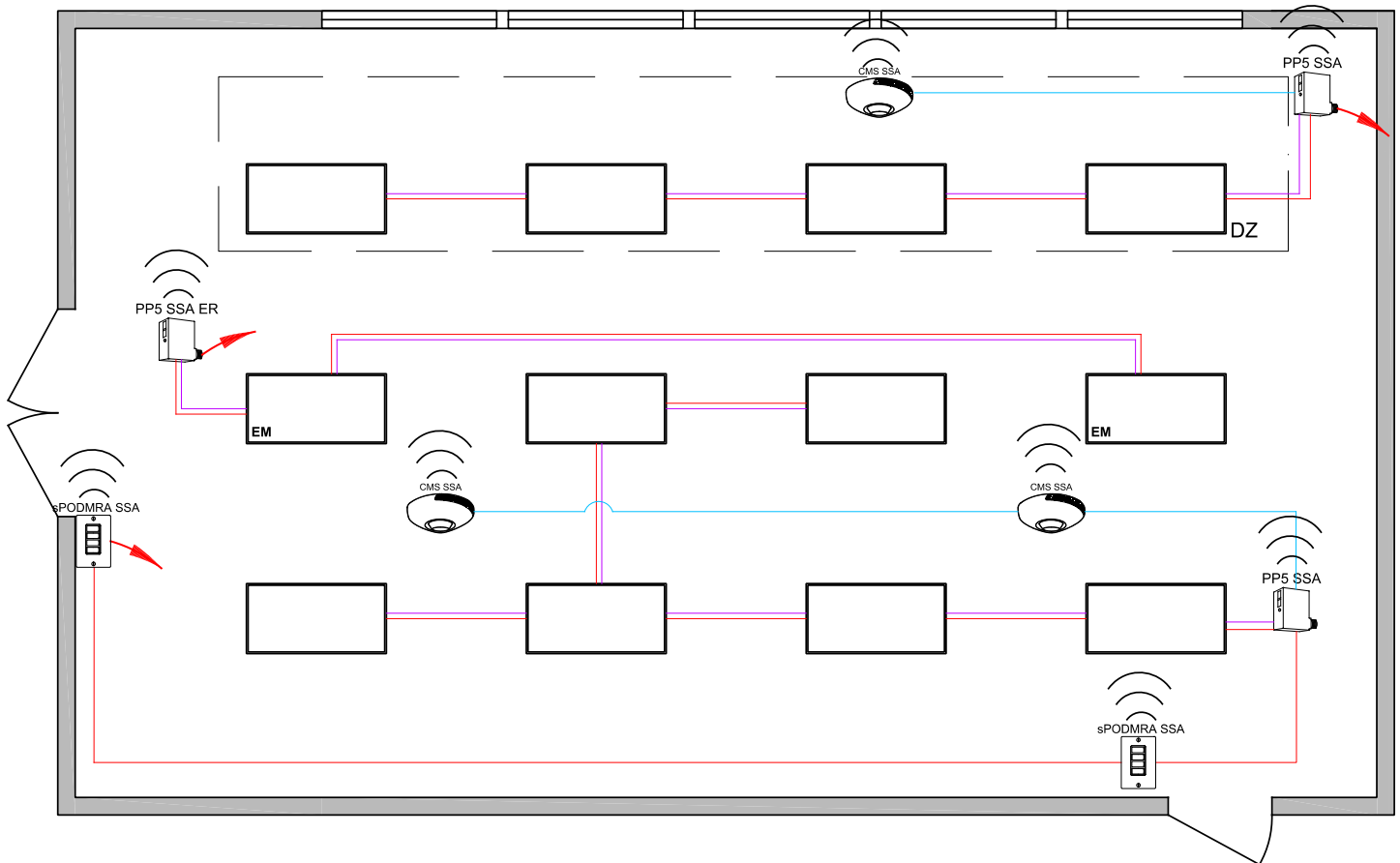





BILL OF MATERIAL		
QTY	PRODUCT #	DESCRIPTION
2	PP5 SSA D 24V	WIRELESS 0-10V DIMMING POWER PACK
1	PP5 SSA D 24V ER	WIRELESS 0-10V EMERGENCY DIMMING POWER PACK
2	SPODMRA SSA DX	WIRELESS DIMMING WALL SWITCH
3	CMS SSA PDT 9	CEILING MOUNTED WIRELESS OCCUPANCY/PHOTO SENSOR
12	SEE NOTE	0-10V DIMMABLE TROFFERS

DIAGRAM LEGEND	
	0-10 VDC DIMMING WIRES
	CLASS 2 LOW VOLTAGE WIRES
	LINE VOLTAGE WIRES
	LINE FEED

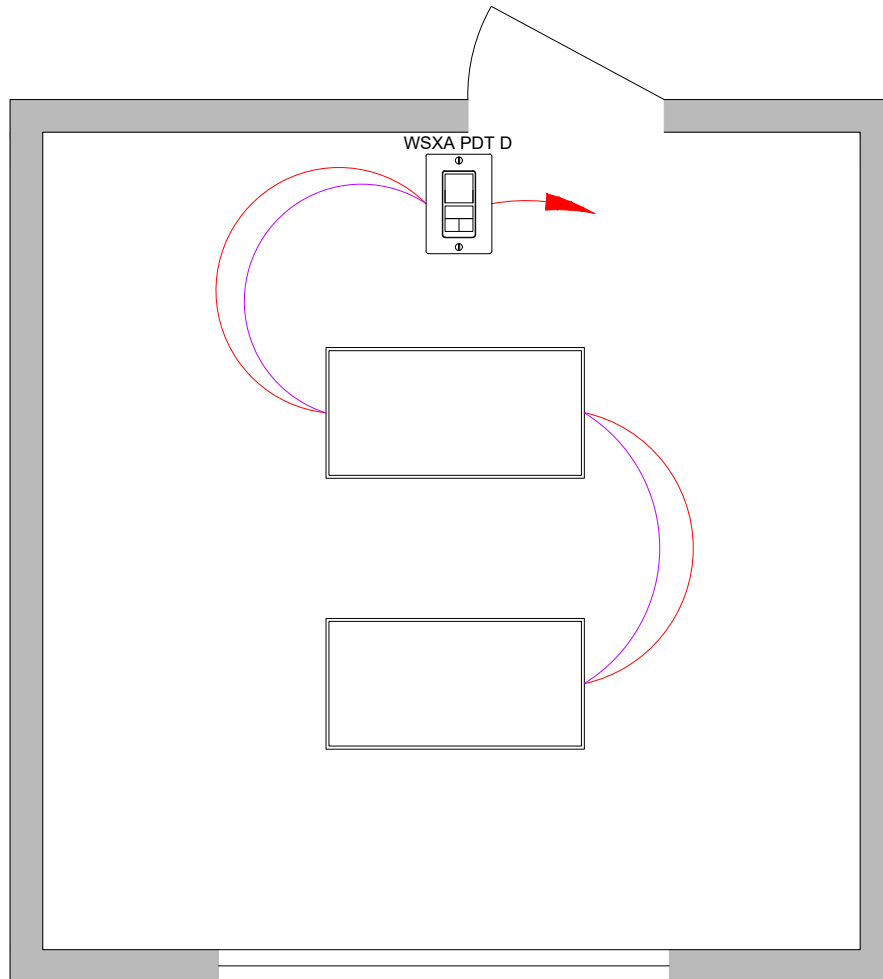
Wireless SensorSwitch AIR is backwards compatible with all SensorSwitch JOT products.

## Private Office: With Wired SensorSwitch Control Devices





BILL OF MATERIAL			DIAGRAM LEGEND	
QTY	PRODUCT #	DESCRIPTION		
2	SEE NOTE	LITHONIA LIGHTING TROFFERS WITH STANDALONE EMBEDDED CONTROLS FROM SENSORSWITCH		0-10 VDC DIMMING WIRES
				CLASS 2 LOW VOLTAGE WIRES
1	WSXA PDT D	SENSORSWITCH WALL SWITCH WITH OCCUPANCY SENSOR AND DIMMING		LINE VOLTAGE WIRES
				LINE FEED

Contact your local lighting Agent or visit [www.sensorswitch.com](http://www.sensorswitch.com) for more information about luminaires available with wired standalone embedded controls by SensorSwitch.

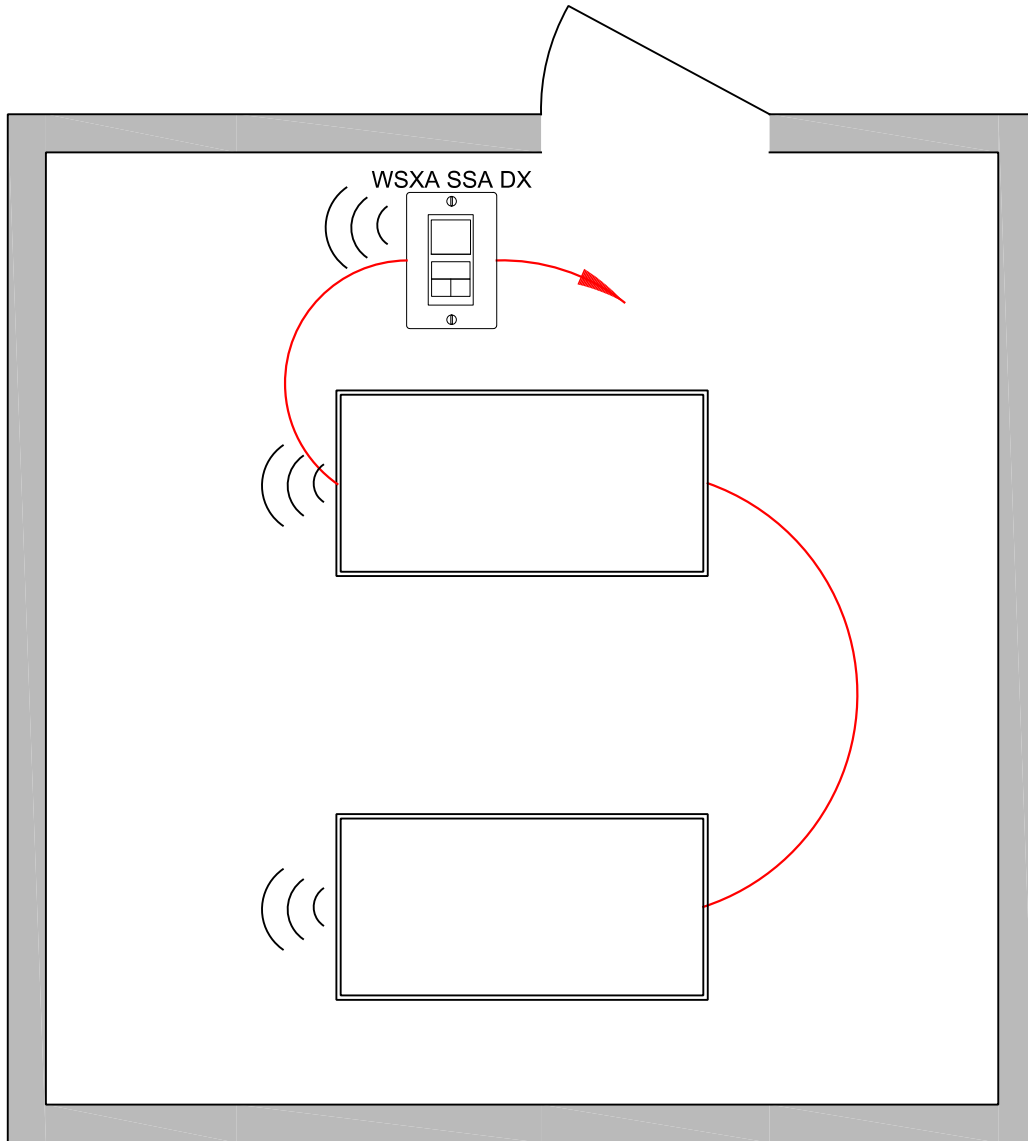
# Private Office: With Wireless SensorSwitch AIR Embedded Control Devices



BILL OF MATERIAL		
QTY	PRODUCT #	DESCRIPTION
1	WSXA SSA DX	WIRELESS OCCUPANCY SENSOR DIMMING WALL SWITCH
1	SEE NOTE	LITHONIA LIGHTING TROFFERS WITH WIRELESS STANDALONE EMBEDDED CONTROLS FROM SENSORSWITCH

DIAGRAM LEGEND	
	LINE VOLTAGE WIRES
	LINE FEED

Contact your local lighting Agent or visit [www.sensorswitch.com](http://www.sensorswitch.com) for more information about luminaires available with wireless standalone embedded controls by SensorSwitch.

# Private Office: With Wireless SensorSwitch AIR Control Devices

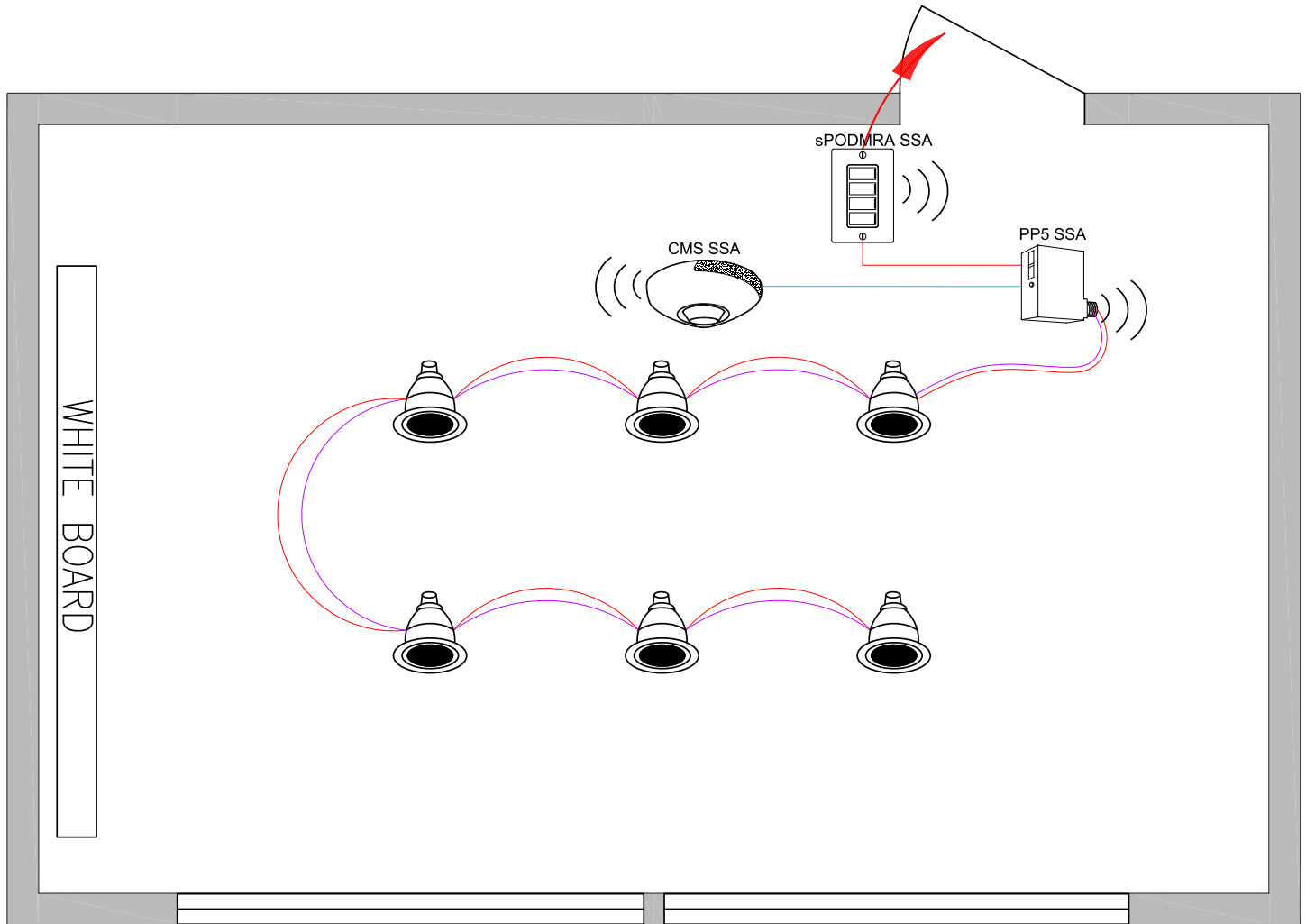

BILL OF MATERIAL		
QTY	PRODUCT #	DESCRIPTION
1	PP5 SSA D 24V	WIRELESS 0-10V DIMMING POWER PACK
1	SPODMRA SSA DX	WIRELESS DIMMING WALL SWITCH
1	CMS SSA PDT 9	CEILING MOUNTED WIRELESS OCCUPANCY SENSOR
6	SEE NOTE	0-10V DIMMABLE DOWNLIGHTS

DIAGRAM LEGEND	
	0-10 VDC DIMMING WIRES
	CLASS 2 LOW VOLTAGE WIRES
	LINE VOLTAGE WIRES
	LINE FEED

Wireless SensorSwitch AIR is backwards compatible with all SensorSwitch JOT products.

# Warehouse: With Wired SensorSwitch Embedded Control Devices

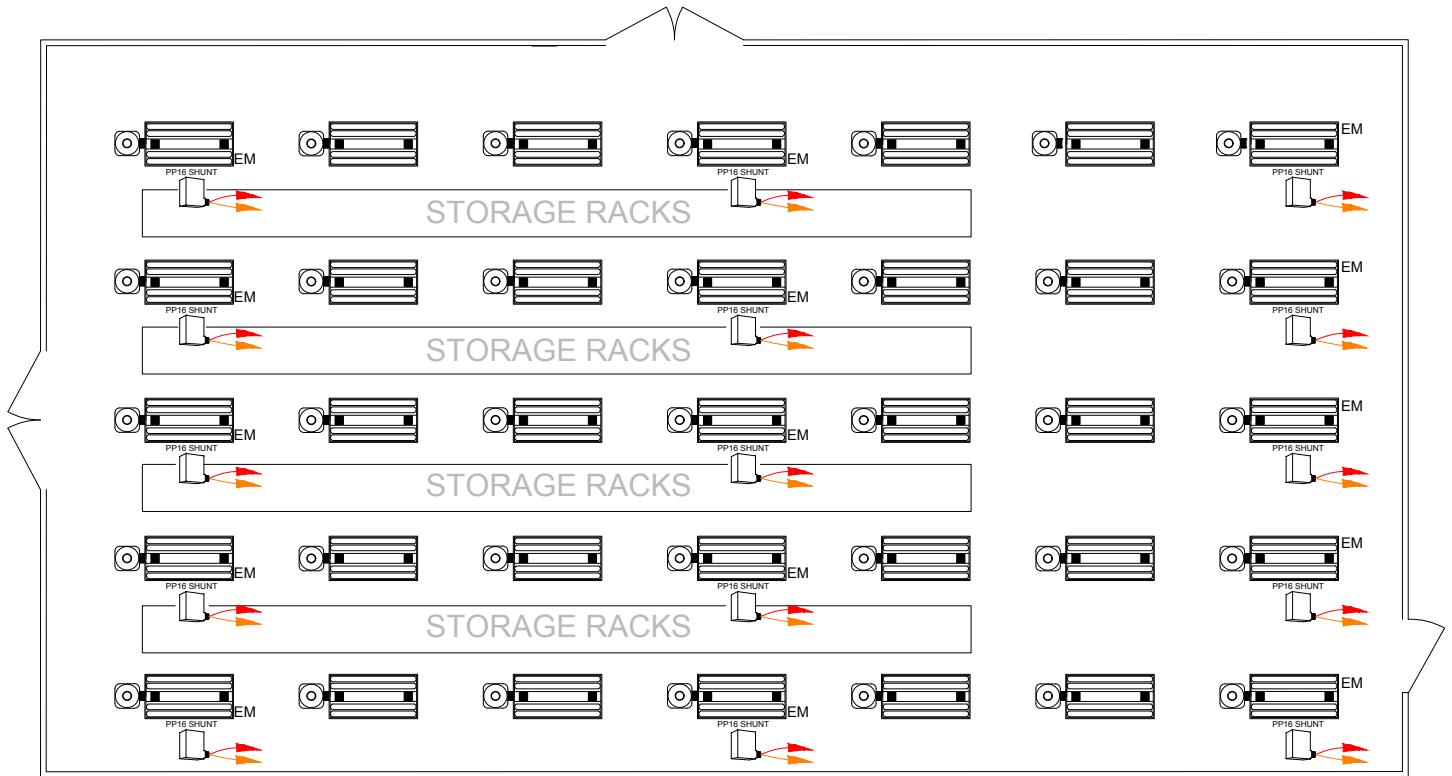

BILL OF MATERIAL		
QTY	PRODUCT #	DESCRIPTION
15	PP16 SHUNT	EM SHUNT RELAY PACK
35	SEE NOTE	LITHONIA LIGHTING HIGH BAYS WITH STANDALONE EMBEDDED CONTROLS FROM SENSORSWITCH (LSXR)

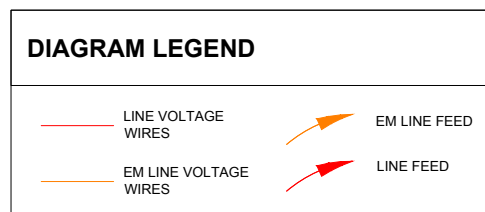

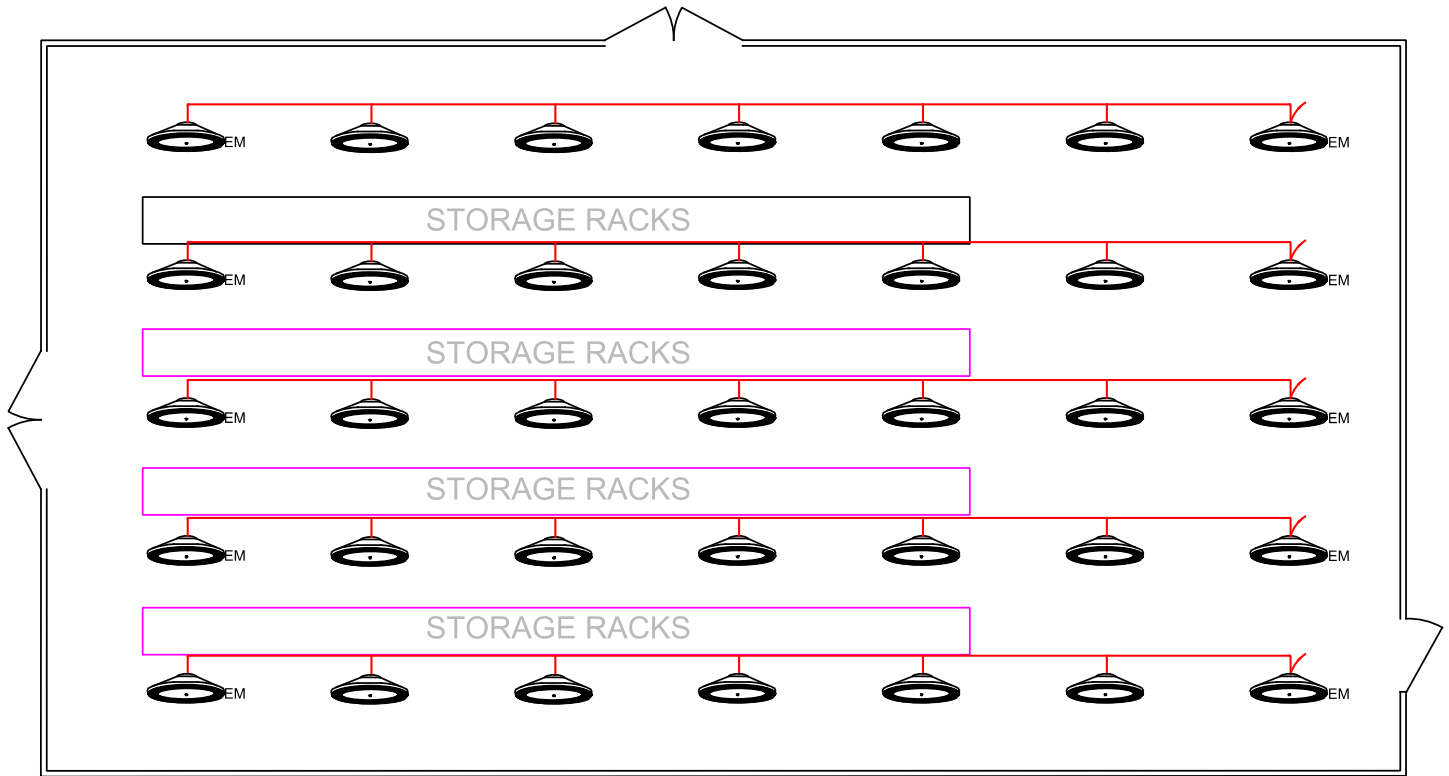

Contact your local lighting Agent or visit [www.sensorswitch.com](http://www.sensorswitch.com) for more information about luminaires available with wired standalone embedded controls by SensorSwitch.

# Warehouse: With Wired SensorSwitch Field Installable Controls



BILL OF MATERIAL		
QTY	PRODUCT #	DESCRIPTION
25	SEE NOTE	LITHONIA REBL HIGH BAY WITH WIRED STANDALONE FIELD INSTALLABLE CONTROLS BY SENSORSWITCH (TLS TWIST-TO-LOCK SENSOR)
10	SEE NOTE	LITHONIA REBL HIGH BAY WITH WIRED STANDALONE FIELD INSTALLABLE CONTROLS BY SENSORSWITCH (TLS TWIST-TO-LOCK SENSOR) AND EMERGENCY BATTERY BACKUP

DIAGRAM LEGEND	
	LINE VOLTAGE WIRES
	LINE FEED

Includes emergency option. For a battery backup option, a dedicated ER circuit is not necessary.

# Restrooms: With Wired SensorSwitch Control Devices

## Public Restroom

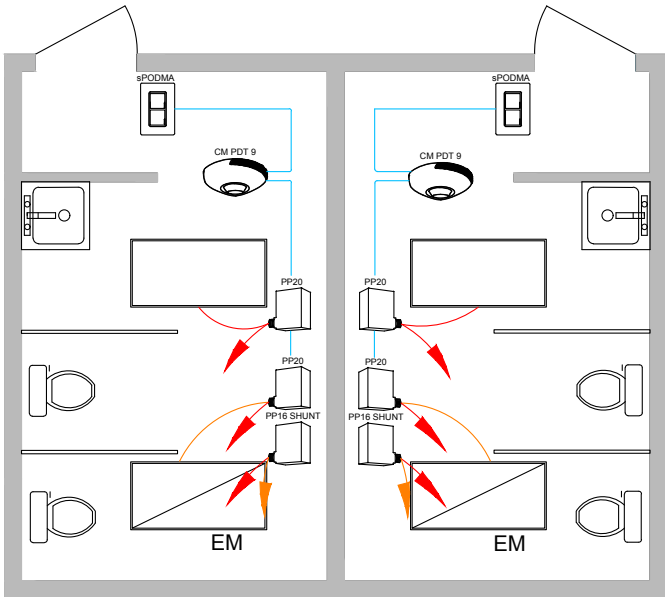

## Private Restroom

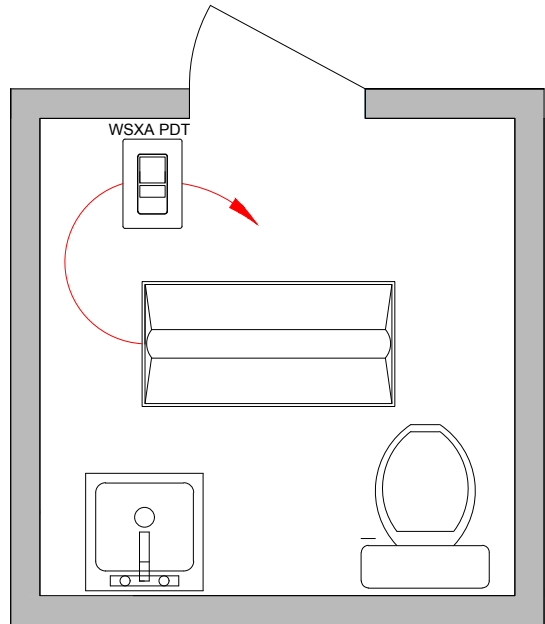

BILL OF MATERIAL		
QTY	PRODUCT #	DESCRIPTION
4	PP20	RELAY MODULE
2	PP16 SHUNT	EM SHUNT RELAY PACK
2	CM PDT 9	DUAL TECHNOLOGY CEILING MOUNT OCCUPANCY SENSOR
2	SPODMA	ON/OFF SWITCH

DIAGRAM LEGEND	
	CLASS 2 LOW VOLTAGE
	LINE VOLTAGE WIRES
	LINE FEED
	EM LINE FEED

BILL OF MATERIAL		
QTY	PRODUCT #	DESCRIPTION
1	WSXA PDT	WALL SWITCH WITH OCCUPANCY SENSOR



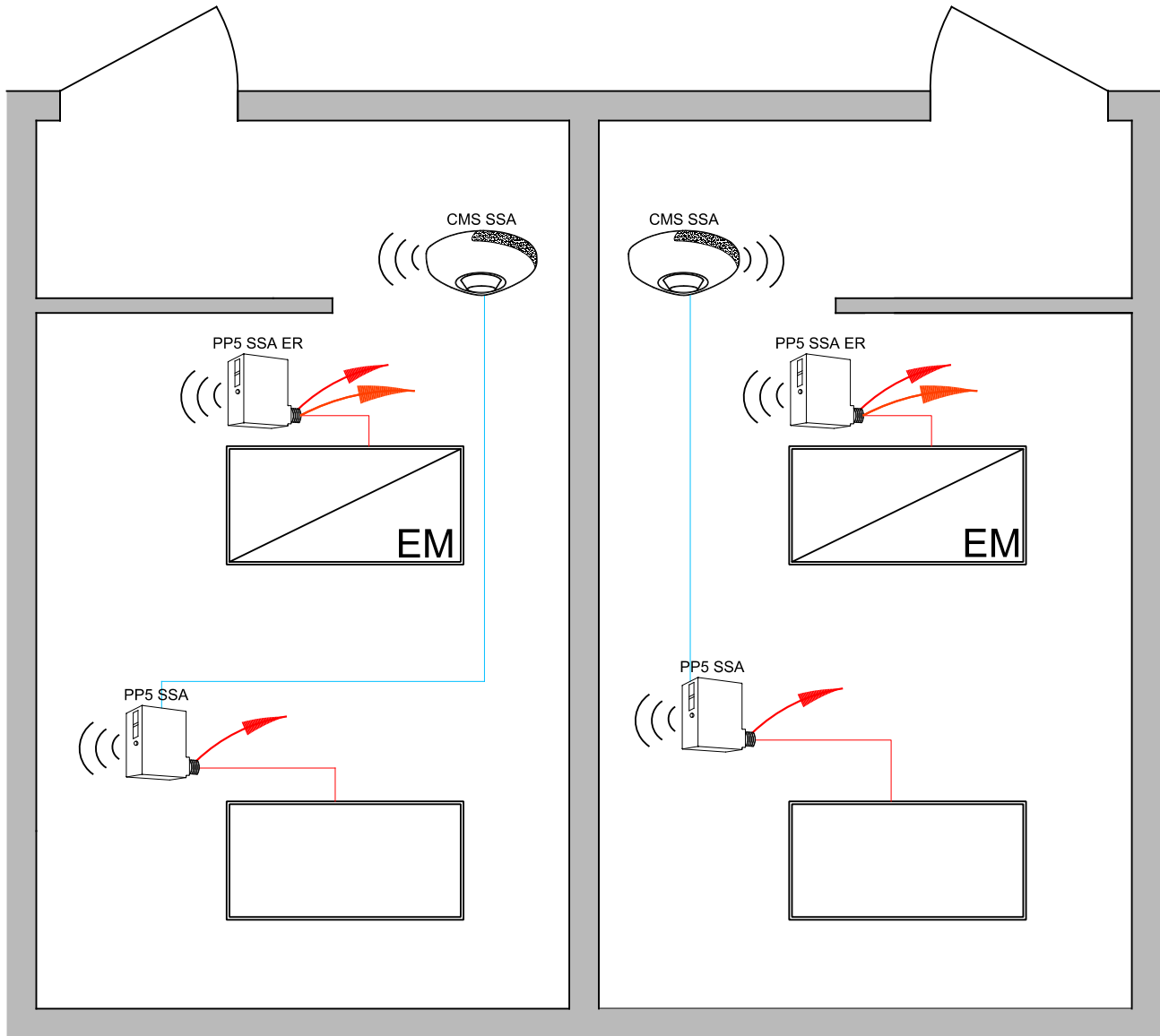

DIAGRAM LEGEND	
	LINE VOLTAGE WIRES
	LINE FEED

Use the WSXA 2P to control lighting and exhaust fan with a single device.

# Public Restrooms: With Wireless SensorSwitch AIR Control Devices



BILL OF MATERIAL		
QTY	PRODUCT #	DESCRIPTION
2	PP5 SSA D 24V	WIRELESS 0-10V DIMMING POWER PACK
2	PP5 SSA D 24V ER	WIRELESS 0-10V EMERGENCY DIMMING POWER PACK
1	CMS SSA PDT 9	CEILING MOUNTED WIRELESS OCCUPANCY/PHOTO SENSOR
4	SEE NOTE	0-10V DIMMABLE TROFFER

DIAGRAM LEGEND	
	Low VOLTAGE WIRES
	LINE VOLTAGE WIRES
	LINE FEED
	EM LINE FEED



Wireless SensorSwitch AIR is backwards compatible with all SensorSwitch JOT products.

# Residential: With Wired SensorSwitch Control Devices

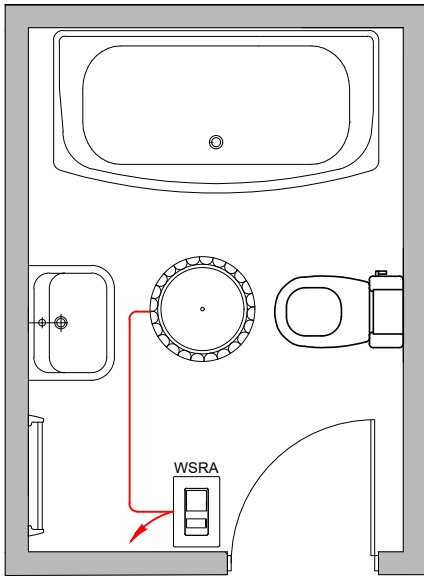
## Bathroom





BILL OF MATERIAL		
QTY	PRODUCT #	DESCRIPTION
1	WSRA	AUTO ON /AUTO OFF WALL OCCUPANCY SWITCH

DIAGRAM LEGEND	
	LINE VOLTAGE WIRES
	LINE FEED

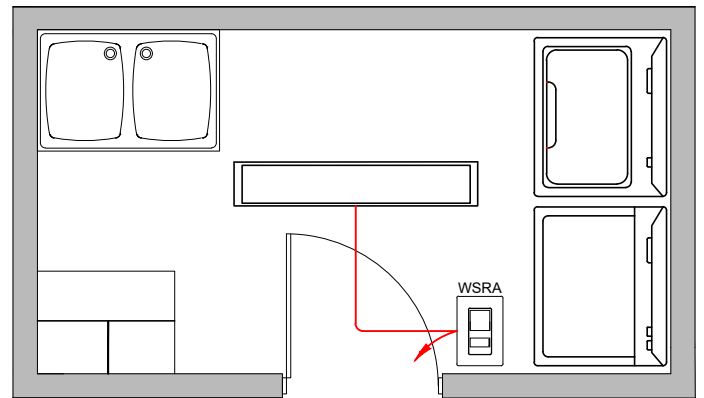
## Laundry Room



BILL OF MATERIAL		
QTY	PRODUCT #	DESCRIPTION
1	WSRA	AUTO ON /AUTO OFF WALL OCCUPANCY SWITCH

DIAGRAM LEGEND	
	LINE VOLTAGE WIRES
	LINE FEED

Use the WSXA 2P to control lighting and exhaust fan with a single device.

# Residential: Kitchen with Wired SensorSwitch Control Devices

## Kitchen

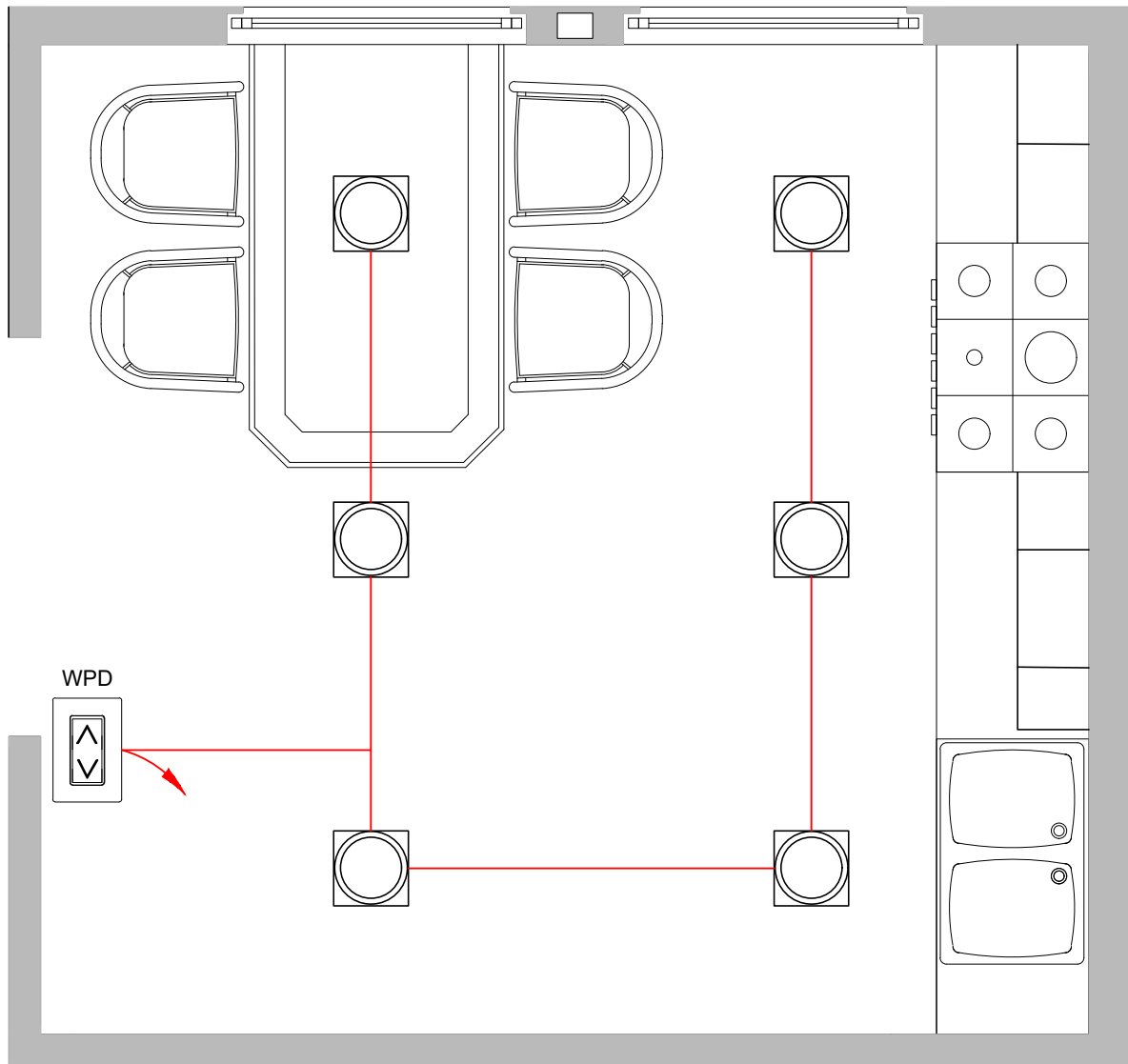



DIAGRAM LEGEND	
	LINE VOLTAGE WIRES
	LINE FEED

BILL OF MATERIAL		
QTY	PRODUCT #	DESCRIPTION
1	WPD	RAISE/LOWER PHASE DIMMER WALL SWITCH



# Performance You Can Count On

[www.sensorswitch.com](http://www.sensorswitch.com)



The Bluetooth® word mark and logos are registered trademarks owned by Bluetooth SIG, Inc. and any use of such marks by Acuity Brands is under license. Other trademarks and trade names are those of their respective owners.